

ReTurn7500

SystemRoMedic™

ReTurn7400

SystemRoMedic™

Art. no.

01-7500

01-7500i

01-7400

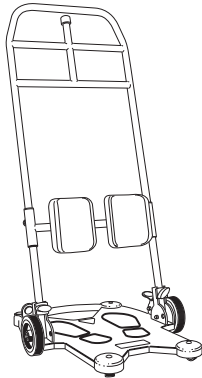

ReTurn7500, with opening for ReTurnBelt

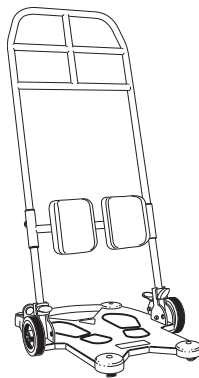

ReTurn7500

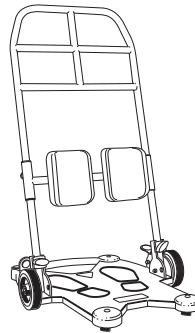

ReTurn7400

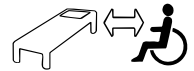

Max: 150 kg/330 lbs

ReTurn7500 and ReTurn7400 are used indoors for shorter transfers between wheelchair and bed, wheelchair and toilet/portable toilet/wheelchair or chair/armchair. ReTurn7500 and ReTurn7400 can also be used to aid repositioning farther back in the chair. Both models are designed for easy manoeuvring and use in confined spaces. They are easy to assemble and disassemble in just two sections for easier transport and storage. ReTurn7500 is available in two versions. One model has an opening at the upper vertical handle for hooking of ReTurnBelt. ReTurn7400 is lower than ReTurn7500 and is designed mainly for children and short adults.

SystemRoMedic is a series of different models of transfer assistive devices. The choice of assistive devices depends on the transfer situation and the patient's functional capability and needs.



Functional inspection

Visual inspection

Check the condition and function of the product regularly. Check to ensure that material is free from damage. If there are signs of wear, the product must be inspected and serviced.



Always read the manual

Always read the manuals for all assistive devices used during a transfer.

Keep the manual where it is accessible to users of the product.

Do not leave the patient unattended during a transfer situation.

The product should be inspected yearly, and otherwise as required, by a qualified technician. Service must be performed by a qualified technician.

Assembly

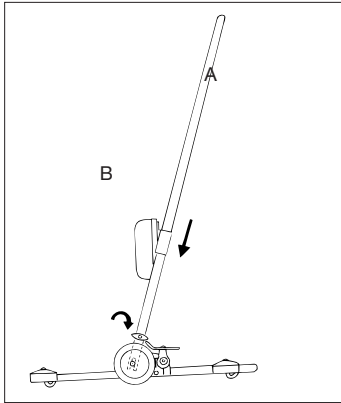

A. Push the rising ladder/tube down into the mounting fixtures on the chassis, so that the height-adjustment buttons are facing towards the caregiver.

B. Insert the fixture knobs and tighten. Check to ensure that the fixture knobs are securely tightened before using the ReTurn.

Special requirements and conditions

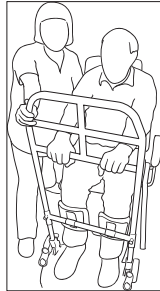

- ReTurn is intended for shorter transfers.
- Return can only be used on flat floor.
- The caregiver must always apply counter pressure in a safe way when the patient is standing up, sitting down and during the actual transfer.

Note! Always perform a risk assessment before using ReTurn.



To transfer with ReTurn, the patient must be able to:

- support weight while standing
- stand up and maintain balance (with support)
- grasp handles
- understand instructions

NOTE! Increased tipping risk.

If ReTurn7400 is used for patients of normal height, it is essential that the patient can support his/her weight while standing and can maintain balance for a prolonged period.

Transport

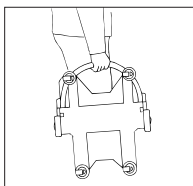

The chassis and raising ladder can be carried separately. Carry the chassis by holding the tube on the front end of the product.

Transport, e.g., by car, and storage are easy, since the ReTurn can be disassembled in two pieces.

Chassis and placement of feet

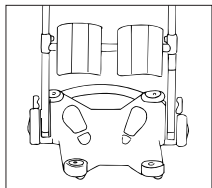

The feet are placed one on either side, see foot markings on base plate.

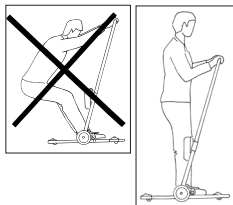

The patient's weight must be centred on the product's support surface (all weight between the wheels); i.e., the patient must be in a standing position. The patient's weight must not be outside of the support surface.

Brakes

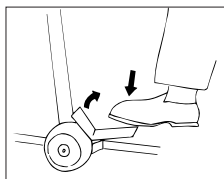

There is a brake for each wheel. With your foot, press down on the red marking on the brake plate. Press all the way down.

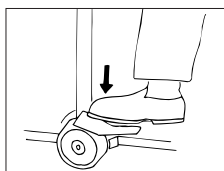

To release the brake, press on the brake plate so that it resumes its original position (green marking); ensure that the wheels roll freely.

Lower-leg support

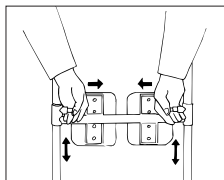

Adjust the lower-leg support so that the upper edge of the plate is about 3 cm/two fingers below the lower edge of the kneecaps. Pull the two pins to loosen. Adjust to the appropriate height. Ensure that the pins lock securely into place. The lower-leg support can also be adjusted laterally.

Testing standing function



ReTurn is ideal for testing a patient's standing function in cases where there is uncertainty as to whether the patient is able to rise from a seated to a standing position.

Training standing function



ReTurn can be used to train the patient's standing, sitting and sit-to-stand function. To measure improvement, use a stopwatch or clock with a second hand to time the patient.

Farther back in the chair

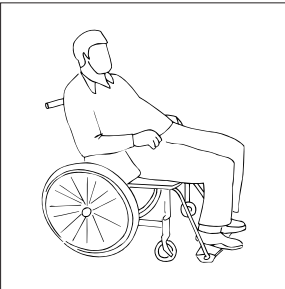

If the patient slides forward in the wheelchair, the ReTurn can be used to help the patient to slide farther back in the chair.

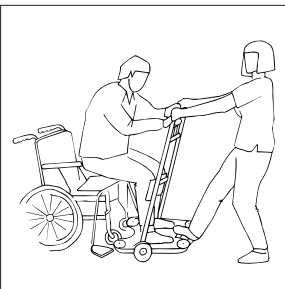

Remove/raise the wheelchair foot plates, and then run the ReTurn in towards the wheelchair. The patient places his/her feet on the foot plate, grasps the raising ladder, leans forward, and then lifts from the seat. The caregiver provides counter pressure. Slide the patient farther back in the chair when he/she has lifted slightly from the seat.

Transfers



Bed to wheelchair

Place the wheelchair at some distance from the bed to allow enough working space. Lock the wheelchair wheels. Place the patient's feet on the base plate. The patient grasps the raising ladder, leans forward, and then raises himself/herself.



Pull the ReTurn back somewhat, and then steer in towards the wheelchair.



Position the ReTurn close enough to enable good placement in the wheelchair. The caregiver applies counter pressure before the patient sits down.

Using ReTurnBelt together with ReTurn7500

See manual for ReTurnBelt.

ReTurnBelt is used for raising from a seated to a standing position, and for support in the standing position in combination with the use of ReTurn transfer platform. ReTurnBelt has a more rigid lower section for easy application and an elastic upper section for a better and more comfortable fit. ReTurnBelt has several gripping alternatives and a locking strap for extra support and safety in connection with the use of the ReTurn platform.

Two caregivers with ReTurnBelt

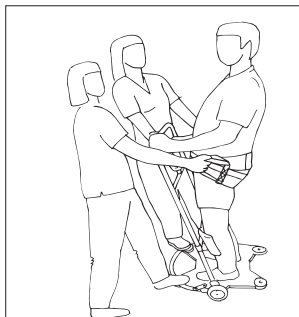
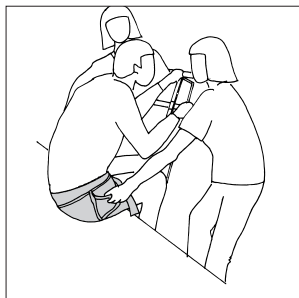

Brake the wheels on the ReTurn. The patient then leans forward and grasps the handles on the ReTurn. The caregivers then grasp the handles on the ReTurnBelt.

ReTurnBelt allows different gripping alternatives, and helps and encourages the patient to lean forward. One caregiver helps the patient to lean forward and provides support during raising.

One caregiver with ReTurnBelt

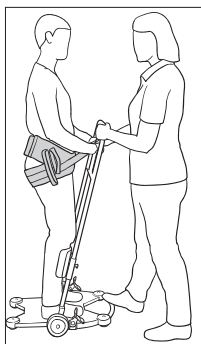
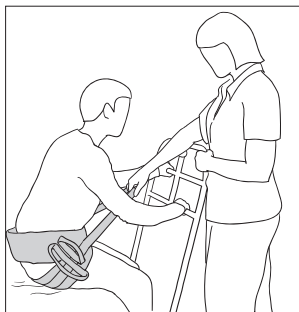

Fasten the clasp without tensioning the strap. A click is heard when the clasp is secured.

Brake the wheels on ReTurn.

The caregiver encourages the patient to lean forward while providing support during raising by grasping either a handle or the strap.

The patient leans forward and grasps the handles on ReTurn.

When it is necessary to attach ReTurnBelt to ReTurn7500

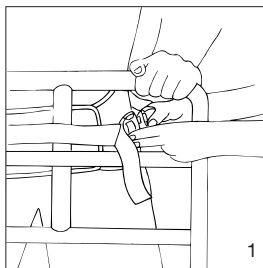

ReTurn7500

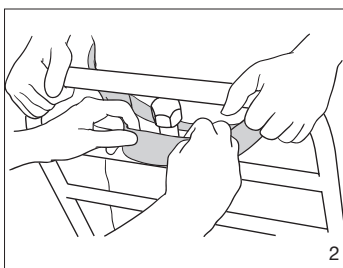

ReTurn7500, with opening for hooking of ReTurnBelt

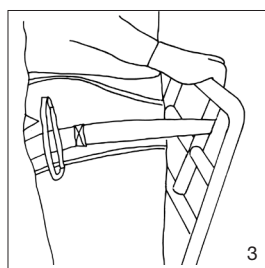

ReTurn7500:

Do not secure the clasp on the ReTurnBelt before rising. When the patient is in a standing position facing the ReTurn, the strap can be placed around one of the vertical handles.

Secure the clasp on the ReTurnBelt. A click is heard when the clasp is secured. (Image 1)

ReTurn7500, with opening on the upper vertical handle:

Fasten the clasp on the ReTurnBelt without tensioning the strap. A click is heard when the clasp is secured.

When the patient is in a standing position facing the ReTurn, the strap is passed through the opening in the upper vertical handle and placed against the middle support bar. (Image 2)

Now, transfer the patient with ReTurn. Plan carefully to ensure that the transfer is as short as possible. (Image 3)

Sitting down

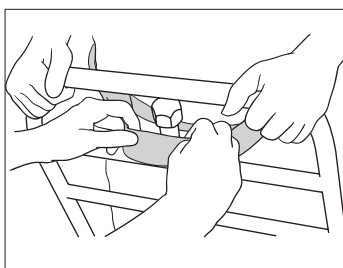
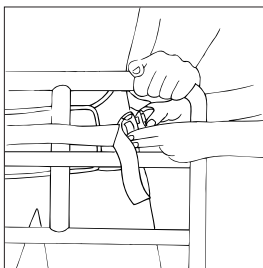

Brake the wheels on the ReTurn.

Ensure that the patient is standing in a secure position facing the ReTurn, so that the locking strap is loosened.

Undo the clasp and remove the strap from the ReTurn.

Fold it under the edge of the belt, so that it does catch on anything.

Help the patient into a seated position with the help of the ReTurnBelt.



To toilet/shower chair

For transfers to the toilet, space is allowed for the caregiver to assist the patient with the pants. The back also has a small recess that allows the patient to get close to the toilet and achieve a good seated position.

Technical specifications

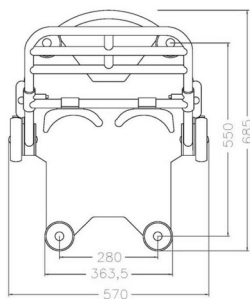

ReTurn7500/7500i/7400

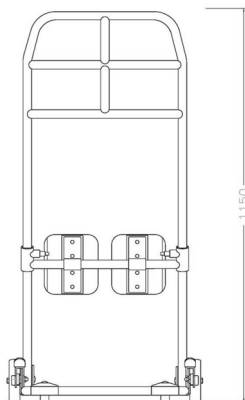

ReTurn7500/7500i

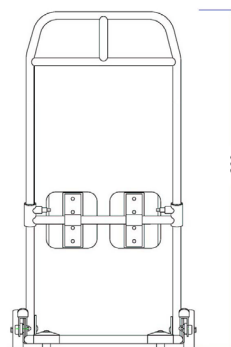

ReTurn7400

- Art.nr 01-7500 Complete ReTurn (5 pcs)
- 01-7501 Ladder to 01-7500

- Art.nr 01-7400 Complete ReTurn (5 pcs)
- 01-7401 Ladder to 01-7400

- Art.nr 01-7500i Complete ReTurn (5 pcs)
- 01-7501i Ladder to 01-7500i

Patented

Care of the product

SWL, Max weight: 150 kg/330 lbs (static load)
Total weight: 16,5 kg/36 lbs

- Use a soft cloth and mild cleaning agent such as dishwashing liquid or car shampoo to clean the ReTurn. Do not use abrasive cloths or brushes to clean the base plate.
- Do not use solvents.
- To disinfect, use 70% alcohol.

Accessories

ReTurnBelt

HeelStrap

SupportStraps

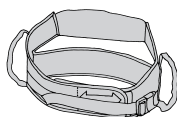

ReTurnBelt



HeelStrap



SupportStraps

AMILAKE
SOUTHERN LIMITED

P O Box 4791 Ferndown Dorset BH22 9WB
Tel: 07857 603031 Fax: 01202 877240
Email: info@amilakesouthern.co.uk